

SL3000 manual

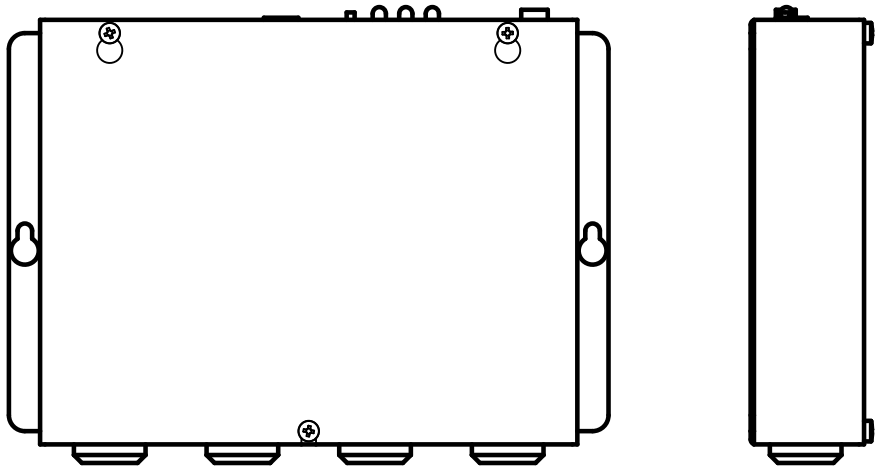

Technical data

Power:	Supply voltage: 230 VAC. Min: 3,9W , Max: 6,9W
Battery:	Battery voltage: 12V. Lead battery. Capacity: 0.8 Ah. Charge: 13.7-13.9 V, max. 200 mA.
Emergency light:	Emergency light output: 12V max 0.5A. Acoustic emergency signal output: 12 VDC max 0.5A.
Inputs:	10-30 Volts; 5 mA. Optically isolated.
Relay outputs:	Max 2A/30V DC, 0,5A/125V AC potential free relay outputs.
Pictogram outputs:	Max 100mA, 12 VDC. Transistor outputs. Open collector.
Size:	205 x 160 x 45 mm (L x W x H).
Weight:	1,5 kg.

Content

General information	4
Installation	5
Component list	5
Wiring diagram - Cable type 1	7
Wiring diagram - Cable type 2	9
Wiring diagram, SafeLine 3000 on a PSTN LINE	11
Configuration	12
Activating the SIM card	12
Mounting	13
Configuration overviews	14
Configuration method	16
Configuration Unit numbers	17
Configuration examples	18
Parameter list	19
Operation	23
Front panel	23
LED indication in car	24
Testing	25
Calling with SafeLine 3000	26
Intercom between machine room & car/pit/Top of car	27
Emergency calling process	28
Service	29
Battery life	29
Troubleshooting	30
Declaration of Conformity	31

General information

This unit was built with state-of-the-art technology and to generally recognised safety related technical standards currently applicable. These installation instructions are to be followed by all people working with the unit, in both installation and maintenance.

It is extremely important that these installation instructions are made available at all times to the relevant technicians, engineers or servicing and maintenance personnel. The basis prerequisite for safe handling and trouble free operation of this system is a sound knowledge of the basic and special safety regulations concerning conveyor technology, and elevators in particular. The unit may only be used for its intended purpose. Note in particular that, no unauthorised changes or additions may be made inside the unit or individual components.

Exclusion of liability

The manufacturer is not liable with respect to the buyer of this product or to third parties for damage, loss, costs or work incurred as a result of accidents, misuse of the product, incorrect installation or illegal changes, repairs or additions. Claims under warranty are likewise excluded in such cases. The technical data is the latest available. The manufacturer accepts no liability arising from printing errors, mistakes or changes.

Declaration of conformity

Download "The declaration of conformity" at our website: www.safeline-group.com

Safety Precautions!

- Only trained professionals, who are authorised to work on the equipment, should install and configure this product.
- This quality product is dedicated for the lift industry. It has been designed and manufactured to be used for its specified purpose only. If it is to be used for any other purpose, SafeLine must be contacted in advance.
- It should not be modified or altered in any way, and should only be installed and configured strictly following the procedures described in this manual.
- All applicable health and safety requirements and equipment standards should be considered and strictly adhered to when installing and configuring this product.
- After installation and configuration this product and the operation of the equipment should be fully tested to ensure correct operation before the equipment is returned to normal use.

Electrical and electronic products may contain materials, parts and units that can be dangerous for the environment and human health. Please inform yourself about the local rules and disposal collection system for electrical and electronic products. The correct disposal of your old product will help to prevent negative consequences for the environment and human health.



Installation

Component list

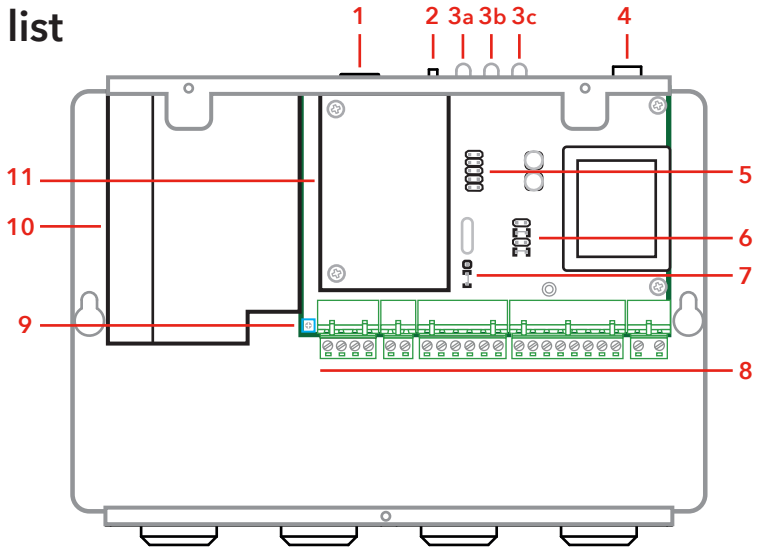

1. Telephone handset (option)

For programming and intercom communication (max 3 substations). Can also be used for external calls. Any standard analogue tonedial telephone can be connected.

2. Reset button

Functions: Reset all alarms. Terminate a phone call in progress. Trigger manual battery check and display of GSM signal quality.

3. LEDs

- a) Mains power,
 - b) Battery status,
 - c) PSTN/GSM Net.
- Call in/out progress

4. RS232 PC connection

For firmware update and programming.

5. Slot for optional extra voice station card

Two supplementary microphone/speaker units can be

connected for the car roof and/or in the lift pit. When the station's alarm button is pressed, an emergency call is emitted. The recorded message can be different for each unit.

6. Jumper for relay

Selects NO/NC for the relays.

7. Jumper for emergency button

Selects NO/NC for the emergency button.

8. Connector terminals: a, b, c, d and e

9. Volume control

For loudspeaker in car. Turn right to increase the volume.

10. 12V Battery

11. Slot for PSTN or GSM card

Component list

PSTN card

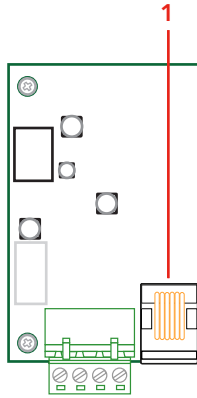

GSM card

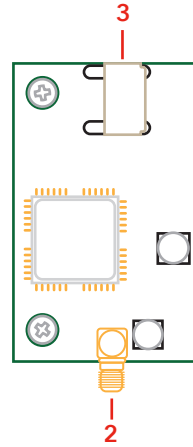

Extra station card

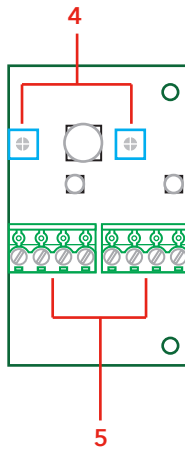

GSM Antenna



- 1. Terminal or RJ12 connector for PSTN line.**
Internal connection of PSTN line.
- 2. GSM antenna connection, SMA**
- 3. SIM-card holder**
- 4. Volume controls**
For the extra remotes. Turn right to increase the volume.
- 5. Terminals**
For the extra remotes.
- 6. GSM antenna**

Wiring diagram - Cable type 1

Unconnected cables must be isolated, to avoid short circuiting.



Cable type 1

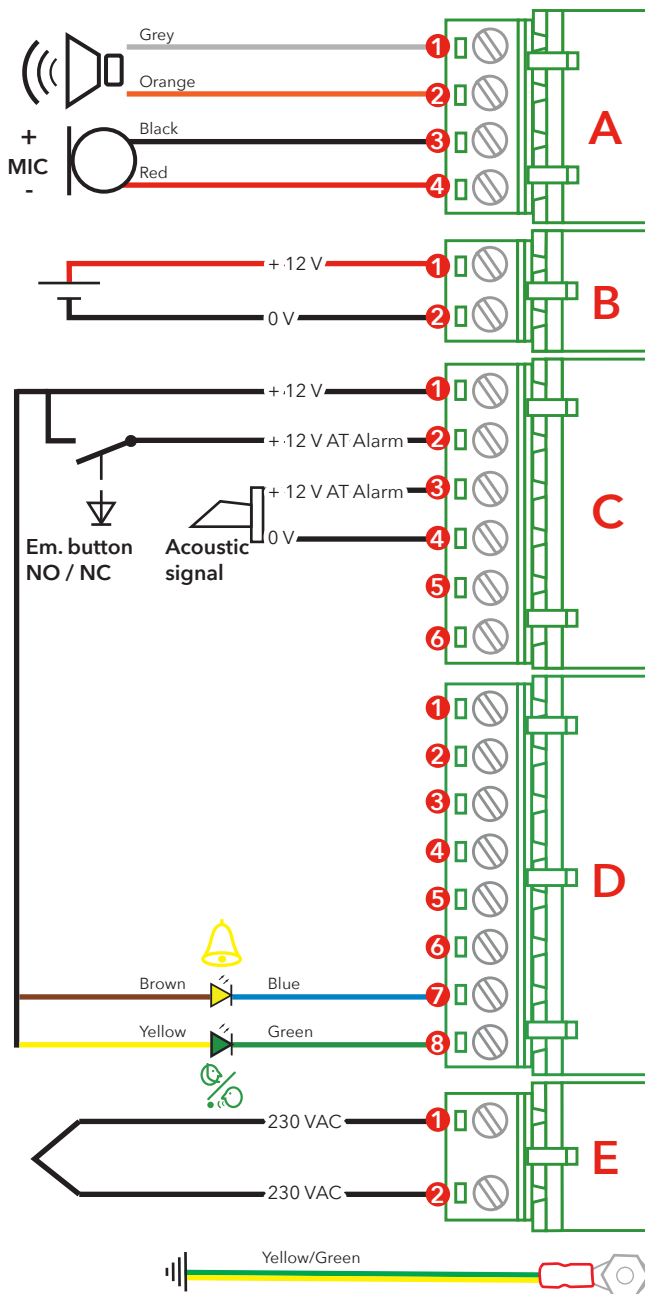
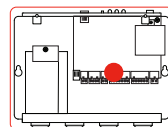

Wiring diagram - Cable type 2

NOTE! Unconnected cables must be isolated, to avoid short circuiting.



Cable type 2

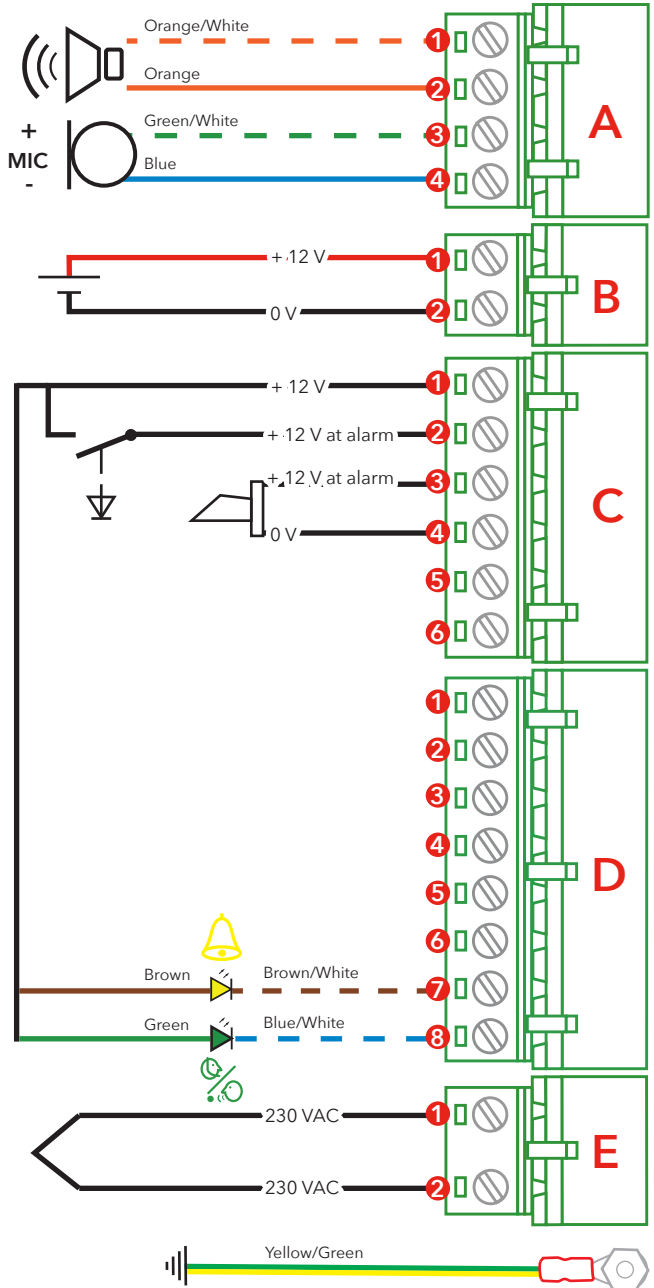
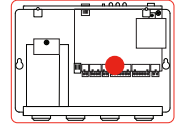

Wiring diagram - Cable type 2

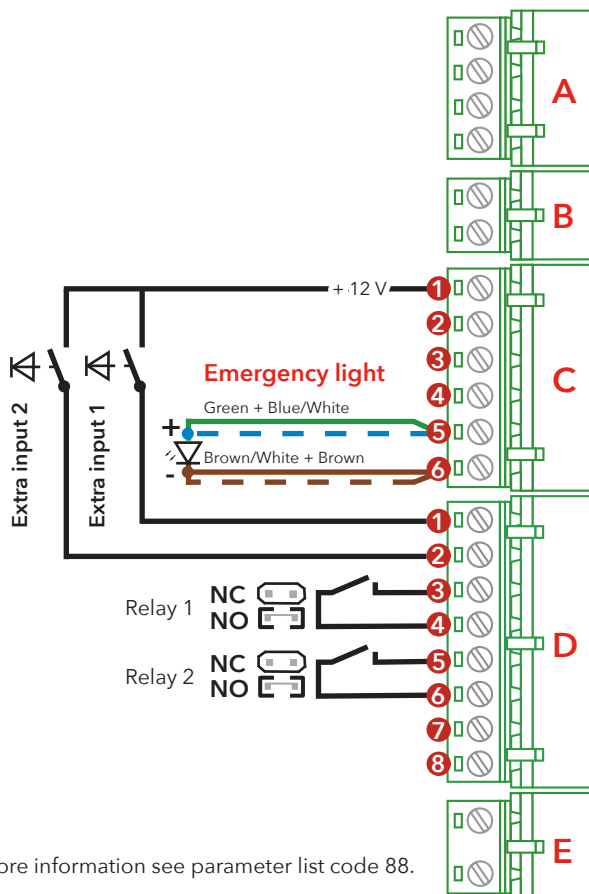
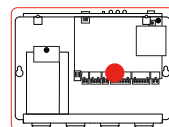
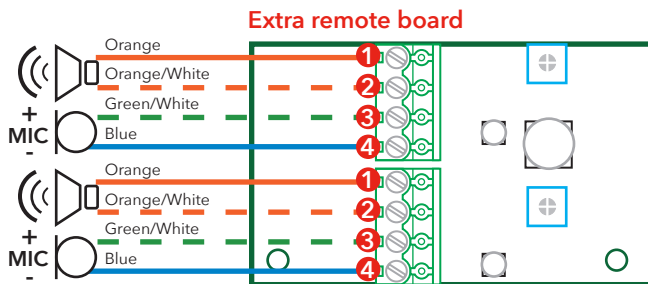

For more information see parameter list code 88.

Wiring diagram, SafeLine 3000 on a PSTN LINE

(Max 9 units)

Connecting the phone line

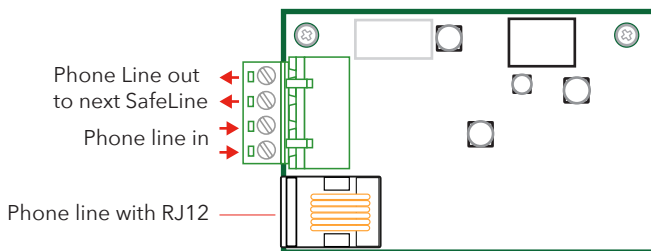

Parallel wiring

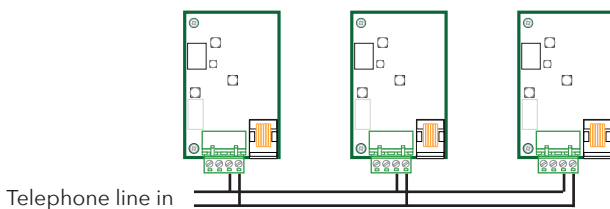

Daisy-chain-wiring (Serial wiring)

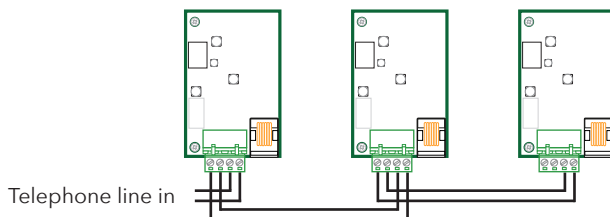

Configuration

Activating the SIM card

If you enter the wrong PIN code 3 times, the SIM card will be blocked (requires PUK code to unblock). The SafeLine 3000 can not be started and the LED (4) will turn red.

If PIN code "1234" is used make sure the SafeLine 3000 software is 2.00 or higher.

Before you can start using a new SIM card, the card has to be prepared and support 2G network. Cards that only support 3G will not function.

The SafeLine 3000 can only recognise the PIN code if the code is set to "0000", "1234", "1111". In some cases the code can also be deactivated. If the PIN code is set to "0000" or if it is deactivated the SIM card can be moved from the SafeLine 3000 to any of SafeLine GSM products. If the code is set to "1234" the SIM card can be moved to another SafeLine 3000 unit if the software version is 2.00 or higher. TIP Do not activate the mailbox or if possible ask your provider to deactivate the mailbox.

If the Pin code is set to "1111" the SIM cards code will be randomly changed by the SafeLine GSM unit and memorised. This way the SIM card can only work with the SafeLine GSM unit unless you use the PUK code for setting up a new PIN code.

The randomly chosen PIN code is memorised by the unit. If you want to upload a new SIM card with PIN code "1111" you will need to first upload a SIM card with PIN code "0000" or "1234" this to clear the old code in memory.

PIN code (set to "0000", "1234" or deactivate).

1. Insert the SIM card in an ordinary cellular phone. In the "Security settings" menu, change the PIN code to "0000". If this is not possible, set the PIN code to "1234" or set the "PIN code request" option to "OFF". (Might not always function)
2. Verify the PIN code by switching your phone off and on again.
3. Make a call from your phone to verify that the SIM card is active, before you move it to the SafeLine 3000.
4. Also make a call to SafeLine 3000 after insertion to check that it is possible to get a proper connection.

You can protect the SIM card against unauthorised use.

1. Insert the SIM card in a cellular phone.
2. In the "Security settings" menu, change the PIN code to "1111". When the SIM card is inserted in the SafeLine 3000, the code will be changed to a random number, thus making it impossible to use the card in another cellular phone unless it is unblocked by means of the PUK code.

Mounting

Unplug the main power and battery before performing any changes. To avoid GSM interference: Place the main unit, the stations and the GSM antenna more than 1.5 meters apart.

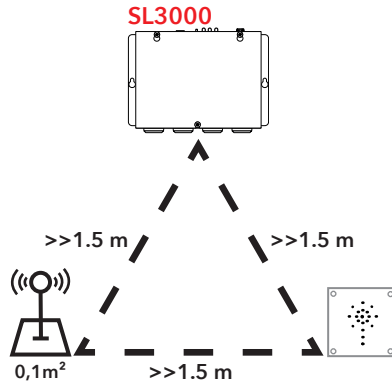

Mounting PSTN board/GSM board

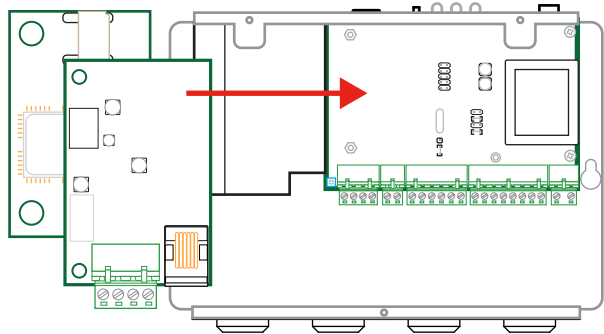

Adding an extra station board.

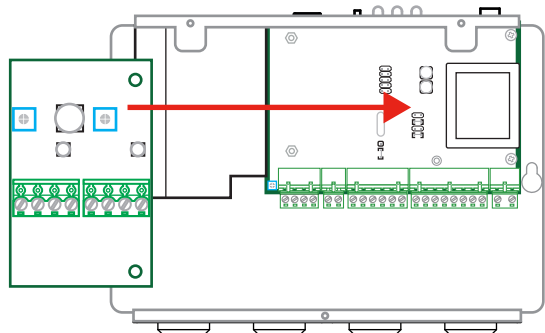

Configuration overviews

Configuration with SafeLine Pro

The unit can be configured at the office prior to the installation or on site after installation. The configuration cable is provided by SafeLine.

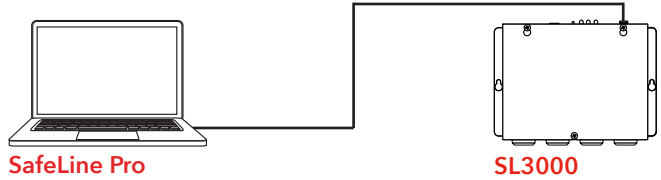

Remote configuration with SafeLine Pro/ProLink

The unit can also be remotely configured at the office after installation. Connect a SafeLine ProLink modem with a phone line to a computer with SafeLine Pro and a serial cable.

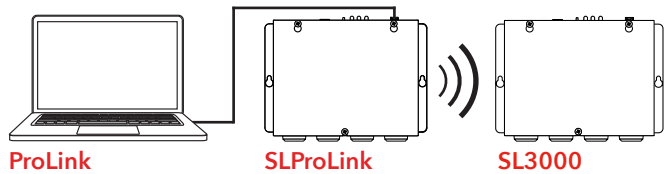

LYNX app

To configure the unit through the LYNX app, the CONNECTable (*CONNECTABLE) is required. Plug in CONNECTable through the unit's serial port and configure the unit through the app just like any other unit.

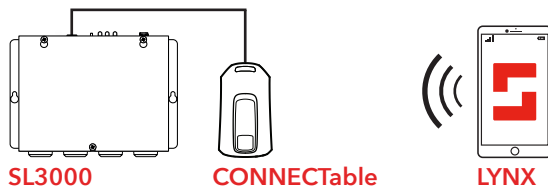

Configuration overviews

On-site configuration with telephone

For configuration, you can use any PSTN tone dial phone.

- Plug the handset into the RJ12 contact of the main station
- (see "Screw terminal for optional telephone handset").
- Enter configuration codes on the handset keypad.

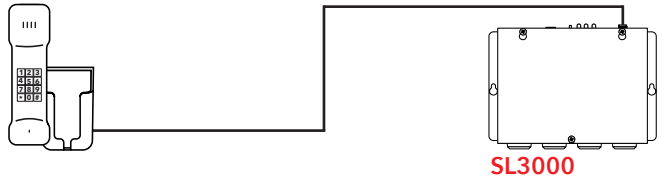

Remote configuration with telephone

For remote configuration, you can use any PSTN tone dial phone.

- Dial the phone number of the SL6+.
- Enter the function codes on the phone keypad to start configuration (password has to be entered, see "Parameter list").

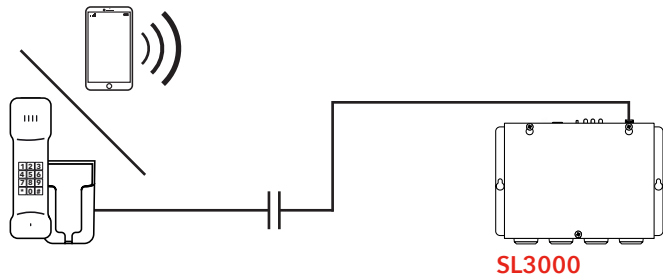

Configuration method

If the time between the operation of two keys exceeds 10 seconds, the code has to be reentered. If the time exceeds 30 seconds, the call is disconnected or configuration mode is ended.

Remote programming with external telephone

On-site programming with handset

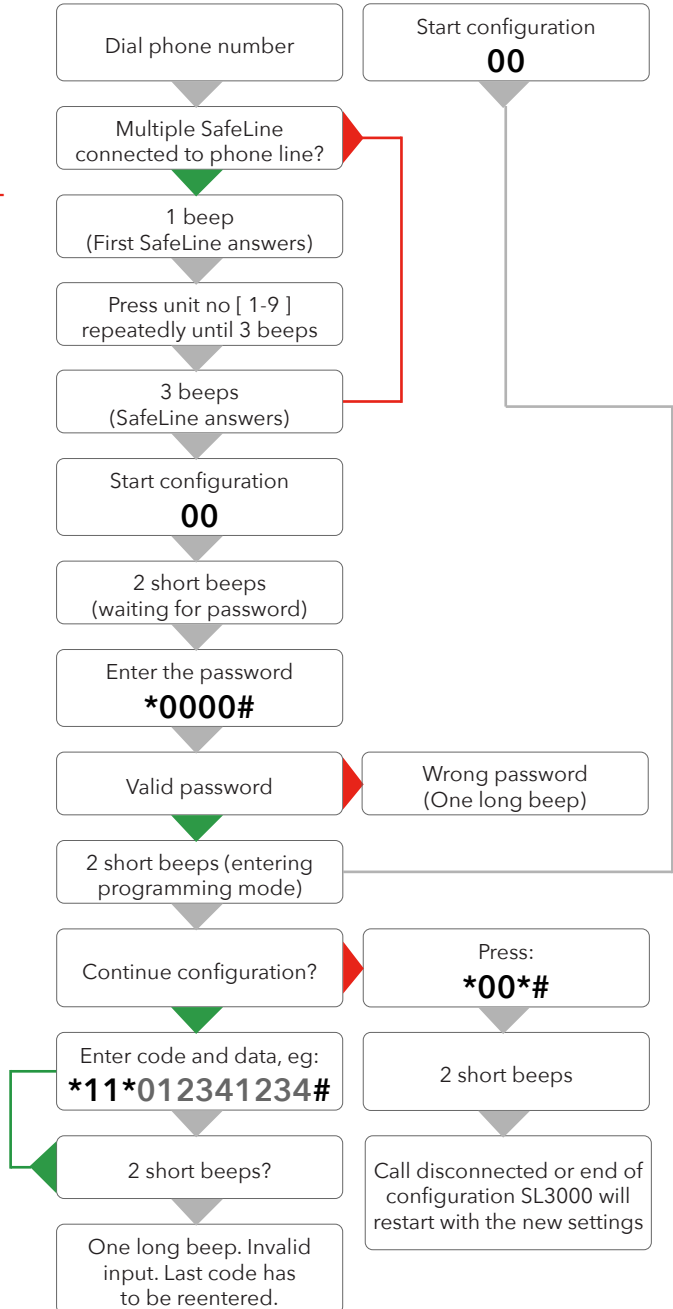

Configuration

Unit numbers

To remotely program a parallel connected unit, the unit number has to be pre-programmed.

If units are connected in series (daisy chain), unit numbers can be remotely programmed.

Remotely program unit numbers in SafeLines connected in series:

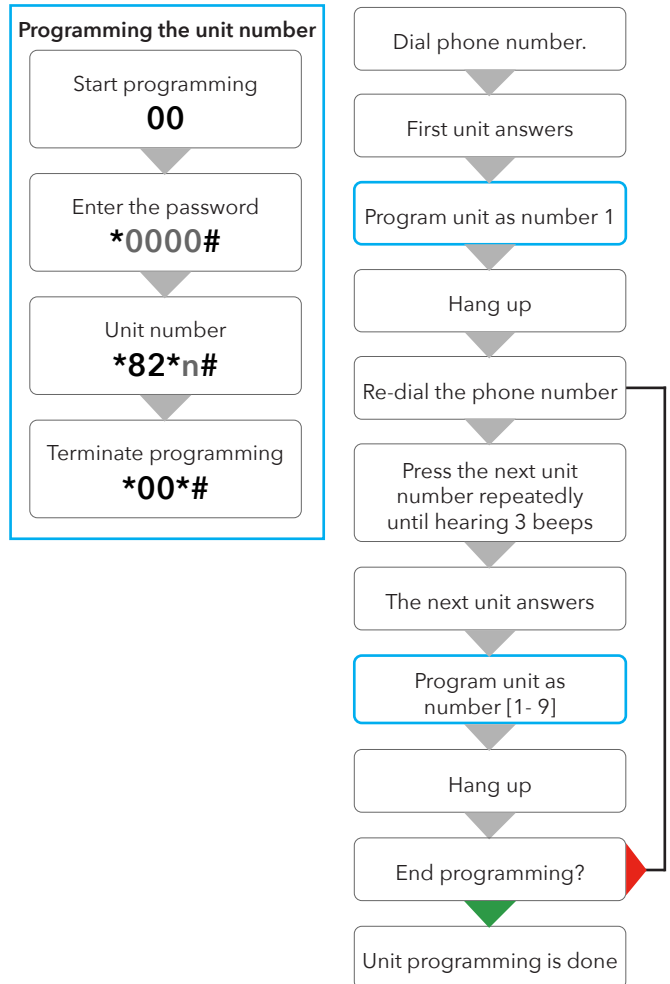

Configuration examples

If at any time you need to start over, use the factory reset command *99*1#.

Please refer to the full configuration setup in the "Parameter list" as these are merely examples.

Example 1. Storing of two different telephone numbers, both to be answered as voice calls.

1. Start configuration:
0 0
2. 1st phone number:
*** 1 1 * 1 2 3 4 5 6 7 8 #**
3. 2nd phone number:
*** 1 2 * 2 3 4 5 6 7 8 9 #**
4. Call type 1st number:
*** 2 1 * 1 #**
5. Call type 2st number:
*** 2 2 * 1 #**
6. Alarm button delay:
*** 8 7 * 0 3 #** - Shown set for 3 seconds
7. End configuration:
*** 0 0 * #**

Example 2: SLCC (SafeLine Call Centre) and 3-day test.

1. Start configuration:
0 0
2. Enter P100 ID code:
*** 0 1 * 4 5 6 4 5 6 4 5 #**
Lift ID code (each lift must have its own unique code).
3. Set test alarm type:
*** 3 1 * 0 #**
4. Set number of days between test alarm:
*** 2 7 * 0 3 #** - Example: 3 days between test alarm.
5. LMS phone number:
*** 1 6 * 9 8 7 6 5 4 3 2 #**
(Only if using SLCC)
6. Test alarm:
*** 1 7 * 1 2 3 1 2 3 1 2 #**
(For P100 use telephone number of SLCC, for Caller ID set *31*4# and telephone number of GSM modem)
7. End configuration:
*** 0 0 * #**

Parameter list

Programming data	Code	Data	Comments
Enter programming mode		00	
Enter password		* - - - - #	Default = 0000
Exit programming mode		*00*#	
Alarm codes	Code	Data	Comments
P100 ID code	*01*	- - - - - - - #	P100 is always 8 digits
CPC ID code	*02*	- - - - - #	CPC 6-8 digits
Q23 ID code	*03*	- - - - - - - - - #	Q23 is always 12 digits
Telephone numbers	Code	Data	Comments
1st Phone number	*11*	- - - - - - - #	Phone number to alarm receiver 0-16 digits.
2nd Phone number	*12*	- - - - - - - #	If calling through a switch board, delay time can be set by adding asterisks between leading number and telephone number. Each asterisk is equal to one second delay.
3rd Phone number	*13*	- - - - - - - #	Example: *11*(0)**1234567#
4th Phone number	*14*	- - - - - - - #	
Call type	Code	Data	Comments
Call type 1st number	*21*	- #	Change call type 1-4:th number: 0 = P100
Call type 2nd number	*22*	- #	1 = VOICE (Default)
Call type 3rd number	*23*	- #	2 = Q23
Call type 4th number	*24*	- #	3 = CPC Change this only if your alarm operator is using any of the mentioned protocols.
Call type LMS number	*30*	- #	LMS(Lift Monitoring System) call type 0 = P100 3 = CPC (Only battery alarm)
Test alarm/battery alarm	Code	Data	Comments
LMS phone number	*16*	- - - - - - - #	LMS(Lift Monitoring System) phone number to alarm receiver/SLCC
Test alarm	*17*	- - - - - - - #	Phone number to test alarm receiver/SLCC
Days between tests	*27*	- - #	Number of days between test alarms, 00-99 days. Always two digits. Max 3 days according to EN 81-28. 00 = No test alarms
Test alarm protocol	*31*	- #	Protocol test alarm 0 = P100 3 = CPC 4 = Phone number used as ID.

Alarm character	Code	Data	Comments
Alarm character 1st number	*41*	-- #	Alarm character. only when using CPC as alarm protocol normally 10 or 27 check with your alarm company !
Alarm character 2nd number	*42*	-- #	
Alarm character 3rd number	*43*	-- #	
Alarm character 4th number	*44*	-- #	
Alarm character LMS	*45*	-- #	LMS(Lift Monitoring System) (Battery alarm) Normally 17
Alarm character Test alarm	*46*	-- #	Normally 26

Distress message	Code	Data	Comments
Record distress message played in the lift car.	*51*	"Speak" #	This message will be played in the lift cabin when the emergency lift telephone starts calling the alarm centre. Make sure that there is no noise in the background when recording the message. Example of message: Please do not panic, the emergency telephone is now calling the emergency call centre.
Record alarm message from Lift Car to alarm central	*52*	"Speak" #	This message will be played to the alarm receiver and in the car when the call is answered. Make sure that there is no noise in the background when recording the message. Example of message: This is an alarm from the lift on 5th avenue. To hear the quality of the message, press "1". To terminate the call press "#".
Record alarm message from car top to alarm central	*53*	"Speak" #	
Record alarm message from Lift pit to alarm central	*54*	"Speak" #	

Distress message	Code	Data	Comments
Options for the recorded distress message	*61*	- #	0 = Disable recorded message. 1 = Enables recorded message.
	61	#	Play the the recorded message.
Options for the recorded message from lift car	*62*	- #	0 = Disable recorded message. 1 = Enables recorded message.
	62	#	Play the the recorded message.
Options for the recorded message from top of car	*63*	- #	0 = Disable recorded message. 1 = Enables recorded message.
	63	#	Play the the recorded message.
Options for the recorded message from lift pit	*64*	- #	0 = Disable recorded message. 1 = Enables recorded message.
	64	#	Play the the recorded message.

Other codes	Code	Data	Comments
Buzzer	*71*	- #	The buzzer will sound at incoming call or at intercom use. 1 = On (Default) 0 = Off
Ring-tone timeout	*72*	- - #	Number of ring signals before dialling the next number.
Hot Line	*75*	- #	Phone connects directly to a fixed recipient without dialling a phone number 0 = Standard phone line (Default) 1 = Hotline
Indicator mode	*78*	- #	0 = Standard 1 = Strictly EN81-28
Maximum communication time	*79*	- #	1 - 20 minutes. Default = 8 min
Reset active alarm	*80*	#	0 = OFF, 1 = ON (Default)
Auto answer	*81*	- - #	No of signals before SafeLine answers incoming call. Can be set from 00-16. 00 = Never answering. (Default = 02)
Unit number	*82*	- #	Program Unit number [0-9], when units share phone line.
Detect dial tone	*83*	- #	0 = Off 1 = On (Default) Set to off if SafeLine has problem to detect the dial tone.
Receipt to alarm receiver	*84*	- #	Select which message(s) to send to the alarm receiver at an alarm call. 0 = None (Default) 1 = Start of alarm 2 = Start+end of alarm
Local button	*85*	- #	Used if car stations has built in alarm button. 0 = OFF (Default) 1 = ON
Break on new alarm	*86*	- #	Disconnects a call longer than 60 seconds at new activation of the alarm button and calls the next emergency call number. 0 = OFF 1 = ON (Default)
Alarm button delay time	*87*	- - #	Delay time from pressing the alarm button until activating the alarm. 00-25 seconds. Default = 10.

Other codes	Code	Data	Comments
Outputs.	*88*	- #	<p>0 = Standard (Default) Relay 1 will be activated when set time reached. Relay 1 will be deactivated when emergency call ends. Relay 2 will be activated when the battery test has failed. Relay 2 will be deactivated by pressing the reset button. 1 = EN81-28 Pictograms Relay 1 will be activated when the emergency button in pressed (yellow pictogram). Relay 1 will be deactivated when the reset button is pressed or if alarm centre presses "5". Relay 2 will be activated when the call is acknowledged (green pictogram). Relay 2 will be deactivated when the call is disconnected. 2 = DTMF-controlled The relays can be activated remotely for 5 seconds. Relay 1 when DTMF "8" is pressed. Relay 2 will be activated for 5 seconds when DTMF "9" is pressed. 3 = Manual - ECF (Emergency Call Fail) Relay 1 will be activated when set delay reached. Relay 1 will be deactivated when the reset button is pressed.</p>
Change password	*91*	- - - #	Change password (default=0000)
Simulate an alarm event	*94*	- #	<p>Triggers an alarm event after programming is terminated. 1 = Emergency call 2 = Test alarm 3 = Battery failure 4 = Microphone/Loudspeaker failure 5 = Emergency call 6 = Maintenance 7 = Main unit power failure</p>
Reset to default settings	*99*	- #	<p>1 = Factory default 2 = Default P100(The following codes will be set): *21*0#, *22*0#, *27*03#, *80*1#, *84*1#, *88*1# 3 = Default CPC(The following codes will be set): *21*3#, *22*3#, *27*03#, *80*1#, *84*1#, *88*1# 4 = Default VOICE(The following codes will be set): *21*1#, *22*1#, *27*03#, *80*1#, *84*1#, *88*1#</p>
Compatability mode	*77*	- #	<p>0=Automatic voice switching The call is validated when there is a voice response. The call is terminated by pressing "#". 1=Kone ECI (lift telephone) When there is a voice response, some ascending tones will be heard. The call is validated by pressing "4". The call is terminated by pressing "0". The call is terminated without receipt notification by pressing "2"(the unit will call the next number). 2=Manual voice switching When there is a voice response, some ascending tones will be heard. The call is validated by pressing "4". Unit is still in automatic mode. To enter manual mode and talk press "*". To listen press "7". Go back to automatic mode press "4". The call is terminated by pressing "#". It is possible to enter manual voice switching mode although the unit is programmed as automatic by pressing "*". No ascending tones will be heard.</p>

Operation

Front panel

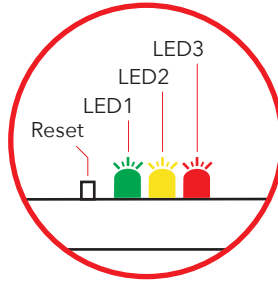

LED	Signal strength
1 2 3	
	100%
	86%
	71%
	57%
	29%*
	15%
	0%

*Minimum signal strenght for using GSM Interface

LED 1 indicates the power supply status:

Continuous green	Mains power supply OK.
Flashing red	Battery-operated, with power to the emergency light.
Continuous red	Battery-operated, no power to the emergency light.

LED 2 indicates active alarm and battery condition:

Light off	Battery OK.
Continuous red	Battery test failure.
Flashing red	Battery check in progress.
Rapidly flashing Yellow	Active alarm not reset. Calling out in progress.

LED 3 indicates the phone line's status:

Continuous red	No SIM-card or communication failure (when using GSM).
Flashing red	No telephone line connected. Searching for GSM-network. Audio self test failed.
Flashing green	Telephone line connected. GSM-network OK.
Flashing yellow	Incoming call.
Flashing green	Call connection in progress.
Continuous green	Call connected.

Reset button

Hold for 4 sec	Show GSM signal strenght.
Press 3 times	Start a battery condition test
Press once	Resets an active alarm.

LED indication in car

(microphone/speaker pictograms)



Yellow LED

Call in progress

The Yellow Pictogram LED, is lit as soon as the alarm button is pressed longer than the set delay.



Green LED

Call connected

The Green pictogram LED turns on as soon as the SafeLine unit detects a responding voice. The LED is turned off when the call is terminated.

Standard (*78*0#)

Light off

No alarm activated

Telephone line not OK.

Flashing slowly

Flashing once every 5 seconds
Telephone line not OK.

Flashing once every 5 seconds
Unit is OK.

Flashing quickly

Flashing twice every second
Alarm button active.

Flashing two times every 5 seconds
Alarm filter activated.

Continuous light

Activated alarm. Remains lit until reset.

Call connected.

Strictly EN81-28 (*78*1#)

Yellow LED

Green LED

Flashing

Flashing twice every second
Alarm button active.

Continuous light

Activated alarm. Remains lit until reset.

Call connected.

Testing

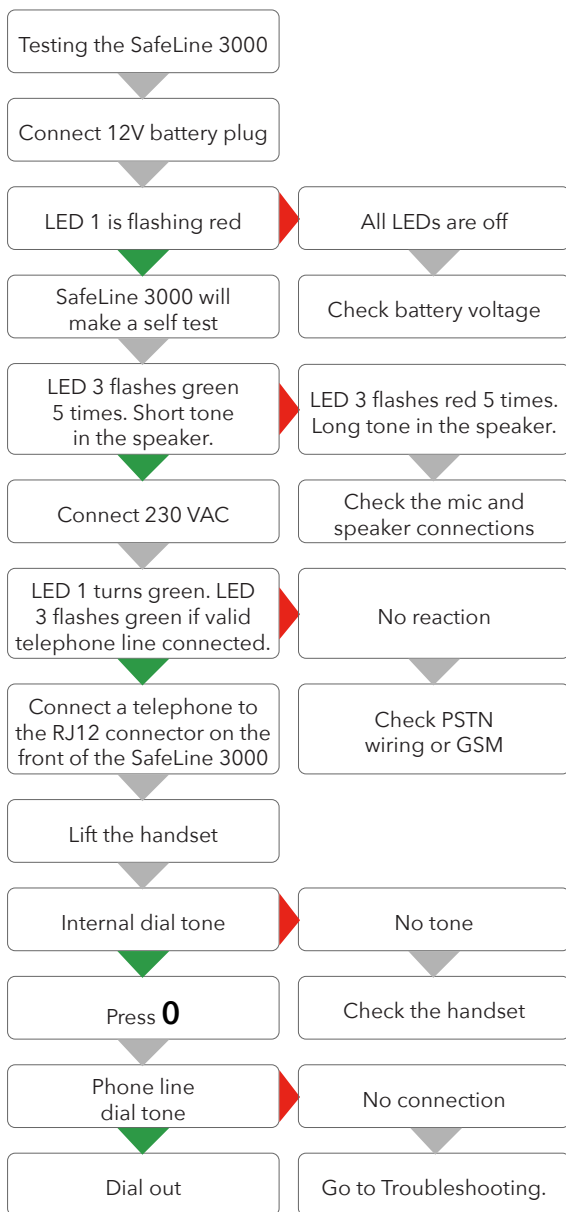

Calling with SafeLine 3000

The SL3000 can call in the following ways:

1. Intercom between machine room and car/pit/car-top, see below.
2. Make calls with a normal fixed phone line and through GSM.
3. Emergency calls to numbers at the press of the alarm button.
4. Test alarms at preset intervals.
5. Send receipts to SLCC alarm receiver for defined conditions.
6. Send SMS to one or several GSM phones at defined conditions (GSM only).
7. Provoke test calls.

Intercom between machine room and car/pit/car-top.



Intercom between machine room & car/pit/Top of car

Press 0 to dial external
telephone number.

Press 2 to call the car-top.

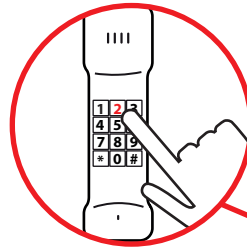

Press 1 to call the lift car.

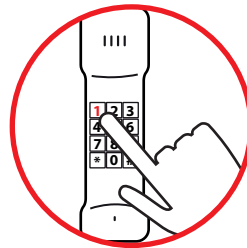

Press 3 to call the lift pit.



Press 00 to enter programming mode.

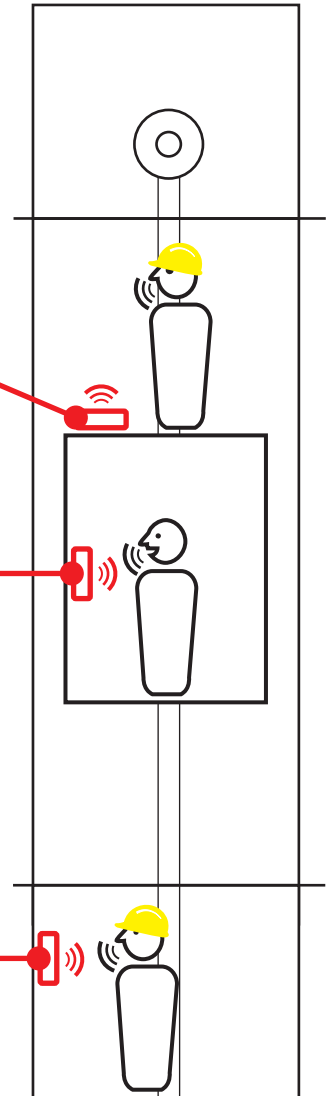

Emergency calling process

With 4 stored telephone numbers in the system, each number can be called 3 times. This adds up to the 12 call limit.

Push the alarm button in the lift cabin to initiate an emergency call. To restart the dialling process, push the alarm button again.

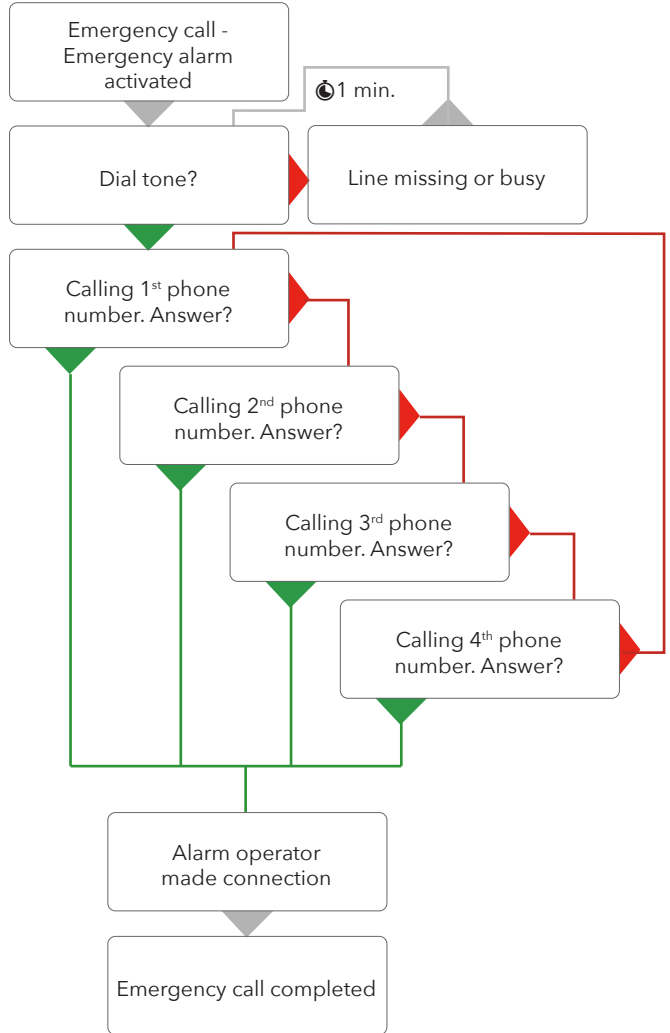

Battery life

The expected life of a lead battery is approximately 3 years, but several factors can affect the battery's life time.

E.g.:

- Ambient temperature.
- Humidity.
- Long-time storage of the battery, before powering.
- If the battery has been completely discharged for a longer period of time, it will never regain full capacity.

Battery status check

An automatic battery status check is carried out every 7 days. If the battery test fails, a battery alarm will be emitted to an alarm receiver. If so programmed, relay 2 will be activated when the battery test has failed and can be reset by pressing the reset button.

Battery test

If the reset button is pressed 3 times within 2 seconds, a battery test will be performed. The battery test takes about 20 minutes. To cancel the battery test, disconnect all power. If the battery is low, the test will be cancelled and LED 2 and the battery alarm relay is activated.

Mains power failure

Mains power failure alarm is sent to the alarm receiver (SLCC) after 15 minutes of mains power failure.

Testing the battery alarm:

Unplug the battery terminal during the battery status check. The SafeLine 3000 will now emit a battery alarm and LED 2 and battery alarm relay will be activated(if so programmed).

Changing the battery:

- Disconnect the 230V voltage supply.
- Change the battery (article number *Batt0,8A).

Trouble-shooting

Emergency button NO

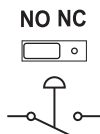

Emergency button NC



The telephone beeps every 5 seconds.

This is to notify the passengers of the ongoing call (anti eaves dropping)

The unit makes an alarm call when powered up.

- Improper type of emergency button selected. Change from NC to NO or from NO to NC.
- Emergency button is stuck.

No sound transmitted from the lift car to the call receiver.

Connect a normal phone (e.g. Comphone) to the plug on the main unit and make a call to the car (press "1"). If the sound transmission is OK in both directions, check if your emergency operator supports the chosen alarm type. If no protocol is used, change the call type to "VOICE". If no sound is transmitted from the lift car, check the polarity of the microphone wiring.

Poor/distorted sound quality.

Volume might be set too loud! Lower the volume and check again.

Interfering noise when the call is connected

If the main unit is installed on the car roof, the problem might be due to induction in the phone cable. According to the phone companies' regulations, the phone line must be installed in a separate cable.

GSM noise.

Change the antenna position when a call is connected until you find the optimal antenna position. Do not install the antenna near the main unit or close to the cabelling.

Can not dial out

- Broken line connection. (LED 3 not blinking green)
- No money on prepaid SIM-card, verify the SIM-card by inserting it into a normal mobile phone.

No voice switching

- The volume is set too high.
- If the main unit is installed on the car roof, the problem might be due to induction in the phone cable.

The unit can not make an alarm call.

At least one phone number (and one ID code if using data identification) must be programmed to enable making a call from the unit. Refer to the parameter list (*11*).

EU Declaration of Conformity

Product: Lift telephone: SafeLine 3000
 Type / model: **SL 3000**
 Article no: *SL3000, *SL3000 GSM, *SL3000_GSM, *SL3000_LINEB, *SL3000_MAIN, *SL3000_MAINB, *SL3000_MINI, *SL3000_MINI GSM, *SL3000_MINIMAIN
Incl. voice stations:
 *SL3000_REMMITSU, *SL3000_XREMB, *SL3000_XREMOTE*SLREM_COP, *SLREM_COP2, *SLREM_G, *SLREM_V2, *SLREM_V2-KIT, *SLREM_V2LED, *SLREM_V2-PIC, *SLREM_V2PICB, *SLREM_V3, *SLREM_V3LED, *SLREM_V3-PIC, *SLREM_V3PICB

Manufacturer: SafeLine Sweden AB
 Year: 2017

We herewith declare under our sole responsibility as manufacturer that the products referred to above complies with the following EC Directives:

Directives

Electro Magnetic Comp. (EMC)	2014/30/EU (For line based versions)
Low Voltage (LVD):	2014/35/EU (For line based versions)
Radio Equipment (RED):	2014/53/EU (For GSM based versions)
RoHS 2:	2011/65/EU

Standards applied

EN 81-20:2014	Lift: Safety & Technical requirements
EN 81-28:2003	Lift: Remote alarm on passenger and goods passenger lifts
EN 12015:2014	EMC: Emission, Electromagnetic compatibility
EN 12016:2013	EMC/Lifts: Immunity, Electromagnetic compatibility
EN 62368-1:2014/AC:2015	LVD: Information Technology Equipment
EN 50581:2012	RoHS: Technical doc. for assessment of restriction of RoHS.

For RED 2014/53/EU, the conformity assessment procedure "Module A" used as described in Annex II. Accordingly, respective manufacturer has done the radio modules conformity assessment:

Standards applied

Article of Directive 2014/53/EU

EN 60950-1:2006+A11:2009+A1:2010+A12:2011+A2:2013	3.1 (a): Health and safety of the user
EN 62311:2008	
EN 301 489-1 v2.1.1 + EN 301 489-5 v1.1.0 Draft	3.1 (B): Electromagnetic Compatibility
EN 301 511 v12.5.1	3.2: Effective use of spectrum allocated

Module	Notified body	Address	NB nr	Test nr
GL865-Dual V3	Dekra Test & Cert	Parque Tecnológico de Andalucía / SeveroOchoa 2, 29590 Spain	1909	53051 RBN.001

Firmware used during assessment

GL865-Dual V3:	16.00.152 / 16.01.150 / 16.01.153
SafeLine SL3000	2.20

Tyresö, 2017-04-07

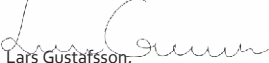
 Lars Gustafsson,
 Technical Manager, R&D, SafeLine Group

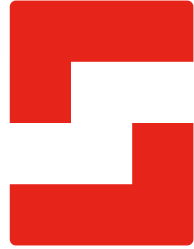
**SafeLine Headquarters**

Antennvägen 10 · 135 48 Tyresö · Sweden
Tel.: +46 (0)8 447 79 32 · info@safeline.se
Support: +46 (0)8 448 73 90

SafeLine Denmark

Erhvervsvej 19 · 2600 Glostrup · Denmark
Tel.: +45 44 91 32 72 · info-dk@safeline.se

SafeLine Norway

Solbråveien 49 · 1383 Asker · Norway
Tel.: +47 94 14 14 49 · post@safeline.no

SafeLine Europe

Industrierrein 1-8 · 3290 Diest · Belgium
Tel.: +32 (0)13 664 662 · info@safeline.eu
Support: +32 (0)4 85 89 08 95

SafeLine Deutschland GmbH

Kurzwannstraße 3 · D-68526 Ladenburg · Germany
Tel.: +49 (0) 6203 840 60 03 · sld@safeline.eu

SafeLine Group UK

Unit 47 · Acorn Industrial Park · Crayford ·
Kent · DA1 4AL · United Kingdom
Tel.: +44 (0) 1322 52 13 96 · info@safeline-group.uk

SafeLine is a registered trademark of SafeLine Sweden AB. All other trademarks, service marks, registered trademarks, or registered service marks are the property of their respective owners.