

# MX3+ manual

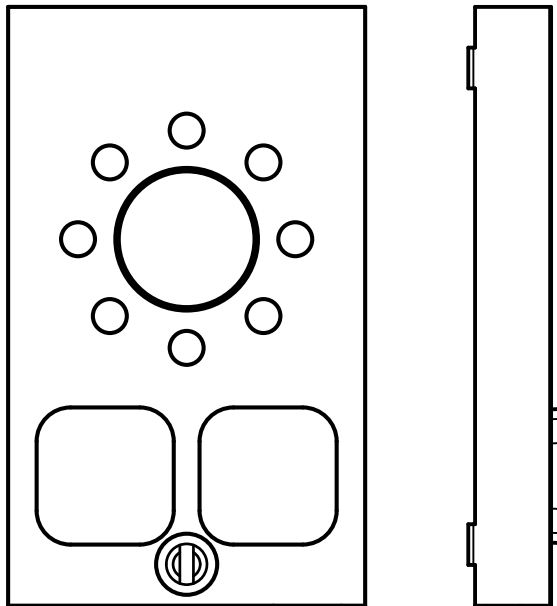

---

# Technical data

<b>Power:</b>	10 - 30 VDC
<b>Consumption:</b>	In standby: 50 mA at 12 VDC Operation: 160 mA at 12 VDC
<b>Input:</b>	10 to 30 VDC, 5 mA optically isolated
<b>Output:</b>	2x 12 to 24 VDC, max 200 mA (transistor negative)
<b>Weight:</b>	Surface mounted with button: 575 g
<b>Size (H x W x D):</b>	Surface mounted with button: 155 x 90 x 31 mm
<b>IP class:</b>	IP 43
<b>Bluetooth:</b>	Bluetooth 4.0 BLE 2,4 GHz
<b>Operation temperature:</b>	+5° - 40°
<b>Air humidity:</b>	30%-90% R
<b>Audio files:</b>	Format WAVE-8 or 16kHz, 16 bit mono, max 16 sec/file

---

# Content

General information	4
<b>Installation</b>	<b>5</b>
Overview and wiring diagram	5
Parallel wiring	6
Wiring diagram, H1/H2	6
Wiring diagram, output 1, 2 and external button	7
Outputs	8
Functions	9
<b>Configuration overviews</b>	<b>10</b>
Configuration interfaces	10
Configuration with telephone	12
Configuration examples	13
Parameter list	14
<b>Operation</b>	<b>19</b>
LED indication for pictogram in car	19
Testing	20
Emergency calling process	21
Troubleshooting	22
<b>Declaration of Conformity</b>	<b>23</b>

# General information

This unit was built with state-of-the-art technology and to generally recognised safety related technical standards currently applicable. These installation instructions are to be followed by all people working with the unit, in both installation and maintenance.

It is extremely important that these installation instructions are made available at all times to the relevant technicians, engineers or servicing and maintenance personnel. The basis prerequisite for safe handling and trouble free operation of this system is a sound knowledge of the basic and special safety regulations concerning conveyor technology, and elevators in particular. The unit may only be used for its intended purpose. Note in particular that, no unauthorised changes or additions may be made inside the unit or individual components.

## Exclusion of liability

The manufacturer is not liable with respect to the buyer of this product or to third parties for damage, loss, costs or work incurred as a result of accidents, misuse of the product, incorrect installation or illegal changes, repairs or additions. Claims under warranty are likewise excluded in such cases. The technical data is the latest available. The manufacturer accepts no liability arising from printing errors, mistakes or changes.

## Declaration of conformity

Download "The declaration of conformity" at our website: [www.safeline-group.com](http://www.safeline-group.com)

## Safety Precautions!

- Only trained professionals, who are authorised to work on the equipment, should install and configure this product.
- This quality product is dedicated for the lift industry. It has been designed and manufactured to be used for its specified purpose only. If it is to be used for any other purpose, SafeLine must be contacted in advance.
- It should not be modified or altered in any way, and should only be installed and configured strictly following the procedures described in this manual.
- All applicable health and safety requirements and equipment standards should be considered and strictly adhered to when installing and configuring this product.
- After installation and configuration this product and the operation of the equipment should be fully tested to ensure correct operation before the equipment is returned to normal use.

Electrical and electronic products may contain materials, parts and units that can be dangerous for the environment and human health. Please inform yourself about the local rules and disposal collection system for electrical and electronic products. The correct disposal of your old product will help to prevent negative consequences for the environment and human health.



# Installation

## Overview and wiring diagram

### 1. Connections

### 2. RS232 PC connection

Firmware update and configuration with SafeLine Pro.

### 3. Volume control

To increase volume, press Button "2"; to decrease volume, press Button "8". It is also possible to adjust the volume in the SafeLine LYNX app (available on both Google Play and Apple App Store).

### 4. Output for additional voice station/hearing loop

When connecting an additional remote station \*CABLE14 is required.

### 5. Keyboard

If extra voice station is connected, connection cable \*CABLE14 is required.

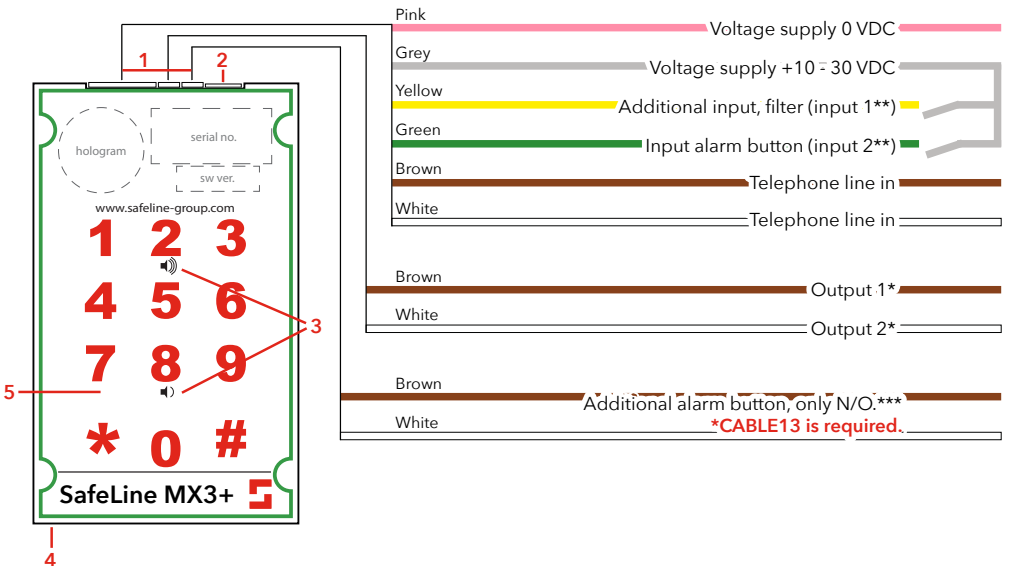

\*Please refer to the Parameterlist \*88\* for programming information. \*CABLE13 is required.

\*\* Serial no. >27000 have configurable inputs.

\*\*\* Serial no. >27000 additional alarm button with NO/NC

# Parallel wiring

In order to access the unit remotely, it needs to be assigned a unit number. Please refer to the Parameter list (\*82\*) for more information.

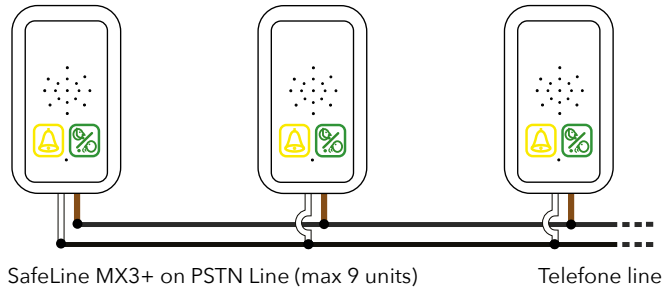

# Wiring diagram, H1/H2

Use CABLE15 to connect SafeLine MX3+ with a hearing loop.

## SafeLine MX3+

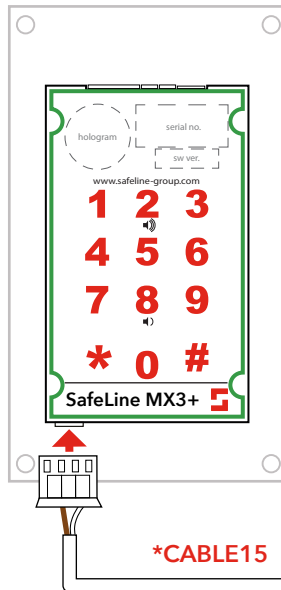

## Hearing loop

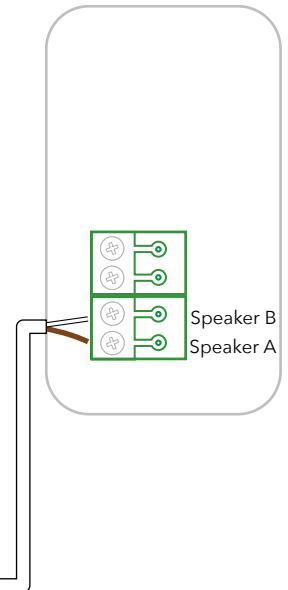

# Wiring diagram, output 1, 2 and external button

Requires that the output is configured for the corresponding function. Please refer to the Parameter list (\*88\*) or the app for more information.

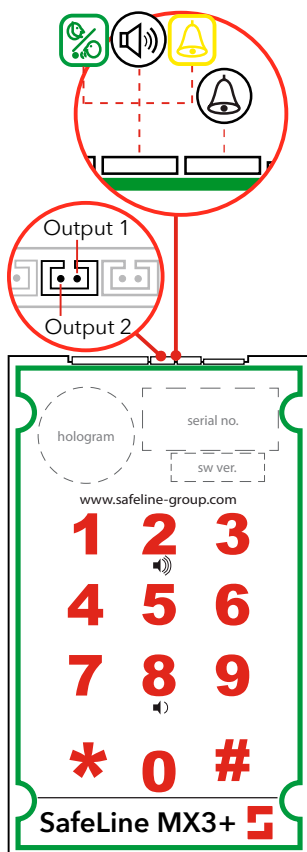

## Outputs

The two **sinking outputs** can be configured independently with a number of functions. The configuration is performed via SafeLine Pro or with the configuration code \*88\*XY#, where X specifies output 1 or 2 and Y specifies the function:

- 0 = Pictogram (Output 1 - yellow, Output 2 - green)
  - 1 = Activate with DTMF 8/9 (Output 1 - DTMF8, Output 2 - DTMF9)
  - 2 = System failure
  - 3 = Emergency bell
- E.g. \*88\*13# configures output 1 for an emergency bell.

## Pictogram yellow

(Output 1, Configuration code 0)

The output is activated at the following events:

- Input for emergency bell is activated.
- Input for emergency bell is set active at a certain time.

The output is deactivated at the following events:

- Distress input deactivated before set time.
- Active alarm ended.
- Reset button (#) is pressed.

## Pictogram green

(Output 2, Configuration code 0)

The output is activated at the following events:

- Voice communication activated.
- Incoming call connected.

The output is deactivated at the following events:

- Outgoing call ended/timeout/cancelled.
- Incoming call ended/timeout/cancelled.
- Reset button (#) is pressed.

Use \*CABLE13 to connect SafeLine MX3+ with external accessories. Output 1 and 2 can be configured independently.

---

# Outputs

## Activate with DTMF 8

(Output 1, Configuration code 1)

The output is activated at the following events:

- DTMF tone 8 is received.

The output is deactivated at the following events:

- 3 seconds after activation.

## Activate with DTMF 9

(Output 2, Configuration code 1)

The output is activated at the following events:

- DTMF tone 9 is received.

The output is deactivated at the following events:

- 3 seconds after activation.

## System failure

(Output 1 & 2, Configuration code 2)

The output is activated at the following events:

- Telephone line OK.

The output is deactivated at the following events:

- Telephone line missing.

## Emergency bell

(Output 1 & 2, Configuration code 3)

The output is activated at the following events:

- Emergency alarm button input active.
- The call is not yet connected.

The output is deactivated at the following events:

- Emergency alarm button input deactivated.
- The call is connected.



---

# Functions

## Silence disconnect

The function will automatically disconnect a call if no sound is received from the alarm operator within a set time. Only works for voice calls, not for P100/CPC/Q23. The configuration is performed via SafeLine Pro or with the configuration code \*92\*X#, where X specifies the time:

- 0 = The function is off.
- 1 = 30 seconds.
- 2 = 60 seconds (default).
- 3 = 90 seconds.

## Volume control through software

The speaker volume is adjusted via the keyboard control. Key 2 raises and Key 8 lowers the volume in 6 steps. The volume can also be adjusted using the command \*76\*X# where X is the desired volume position between 1 and 6. Default value is 3.

The set volume mode are stored in the EEPROM so that the unit remembers the set position.

## External mic/voice station

When a call is activated by the emergency alarm button on the external mic/voice station, the microphone on the external mic/voice station will be used and the internal microphone disconnected. The speaker sound will however be heard from both speakers simultaneously.

---

# Configuration overviews

## Configuration interfaces

The unit has to be connected to a power source before the configuration can begin.

### Keyboard configuration

The integrated keyboard at the rear of the MX3+ enables a fast configuration of the unit.



### Configuration with SafeLine Pro

The unit can be configured at the office prior to the installation or at site after installation, with a configuration cable (\*PCable).

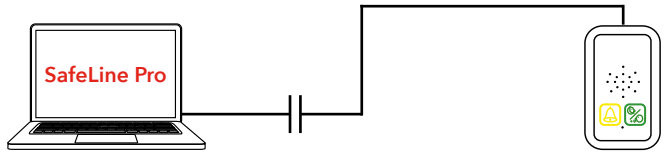

### Configuration with the LYNX app

For configuration via app, download the LYNX app from Google Play or Apple App store and register an account.



---

## Remote configuration

For remote configuration, you can use any PSTN tone dial phone. Please find the instructions of how to perform it in the section "Configuration with telephone".

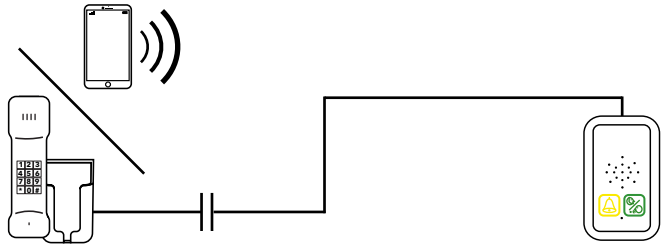

## Remote configuration with SafeLine Pro

Connect an SLPro Link to a computer with SafeLine Pro and a serial cable.

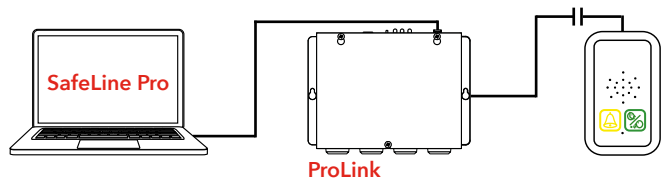

SafeLine Pro can be downloaded on our website:  
<http://www.safeline-group.com/en/downloads/>  
SafeLine Pro 4.42 or later is required.

# Configuration with telephone

If the time between the operation of two keys exceeds 10 seconds, the code has to be re-entered. If the time exceeds 30 seconds, the call is disconnected or configuration mode is ended.

## On-site configuration using the keyboard.

Start configuration:  
**00**

## Remote configuration with external telephone.

Dial phone number.

Multiple units connected to phone line?

1 beep.  
(All MX answers)

Press unit no. [1-9] repeatedly. (Until receiving 3 tones)

3 beeps.  
(Requested unit answers)

Start configuration: **00**  
2 short beeps.  
(Waiting for password)

Enter the password:  
**\*0000#**  
2 short beeps.

Wrong password  
(One long beep).

Continue configuration?

Enter code and data, eg:  
**\*11\*012341234#**

Quit configuration:  
**\*00\*#**

2 short beeps?

2 short beeps

One long beep. Invalid input. Last code has to be re-entered.

Call disconnected or end of configuration. MX3+ will restart with the new settings.

---

# Configuration examples

If at any time you need to start over, use the factory reset command \*99\*1#.

Please refer to the full configuration setup in the "Parameter list" as these are merely examples.

---

## SafeLine emergency telephones

**Example 1:** Storing of two different telephone numbers, one to be answered by P100 code and the other one with voice. For test facility, see example 2.

1. Start configuration:  
**0 0**
2. 1st phone number:  
**\* 1 1 \* 1 2 3 4 5 6 7 8 #**
3. 2nd phone number:  
**\* 1 2 \* 2 3 4 5 6 7 8 9 #**
4. Call type 1st number:  
**\* 2 1 \* 0 #** - Example: Answered with P100 code.
5. Call type 2st number:  
**\* 2 2 \* 1 #** - Example: Answered as voice call.
6. Alarm button delay:  
**\* 8 7 \* 0 3 #** - Example: 3 seconds delay.
7. End configuration:  
**\* 0 0 \* #**

**Example 2:** SLCC (SafeLine Call Centre) and 3-day test.

1. Start configuration:  
**0 0**
2. Enter P100 ID code:  
**\* 0 1 \* 4 5 6 4 5 6 4 5 #**  
Lift ID code (each lift must have its own unique code).
3. Set test alarm type:  
**\* 3 1 \* 0 #** - Example: Test alarm type P100.
4. Set number of days between test alarm:  
**\* 2 7 \* 0 3 #** - Example: 3 days between test alarm.
5. LMS phone number:  
**\* 1 6 \* 9 8 7 6 5 4 3 2 #**  
(Only if using SLCC)
6. Test alarm:  
**\* 1 7 \* 1 2 3 1 2 3 1 2 #**  
(For more information, please refer to parameter \*17\* in the "Parameter list")
7. End configuration:  
**\* 0 0 \* #**

# Parameter list

Configuration	Code	Data	Comments
Enter configuration mode		00	
Enter password		* - - - #	Default = 0000
Exit configuration mode		*00*#	
Alarm	Code	Data	Comments
P100 ID code	*01*	- - - - - #	P100 is always 8 digits
CPC ID code	*02*	- - - - - #	CPC 6-8 digits
Q23 ID code	*03*	- - - - - #	Q23 is always 12 digits
Telephone numbers	Code	Data	Comments
1st Phone number	*11*	- - - - - #	Phone number to alarm receiver: 1-20 digits.
2nd Phone number	*12*	- - - - - #	If calling through a switch board, delay time
3rd Phone number	*13*	- - - - - #	can be set by adding asterisks between leading
4th Phone number	*14*	- - - - - #	number of the switchboard and telephone number for the alarm call receiver. Each asterisk (*) is equal to one second delay. Example #1: *11*0**1234567# Example #2: *11*# deletes the phone number.
Call type	Code	Data	Comments
Call type 1st number	*21*	- #	Change the call type of the stored telephone
Call type 2nd number	*22*	- #	numbers: 0 = P100
Call type 3rd number	*23*	- #	1 = VOICE (default)
Call type 4th number	*24*	- #	2 = Q23 3 = CPC
Call type LMS number	*30*	- #	Change this only if your alarm operator is using any of the mentioned protocols. LMS (Lift Monitoring System) call type: 0 = P100 3 = CPC (Only battery alarm)
Test alarm, battery alarm	Code	Data	Comments
LMS phone number	*16*	- - - - - #	LMS (Lift Monitoring System) phone number to alarm receiver or SLCC.
Test alarm	*17*	- - - - - #	Phone number to test alarm receiver or SLCC.
Days between tests	*27*	- - #	Number of days between test alarms, 00-99 days. Always two digits. Max 3 days according to EN 81-28. 00 = No test alarms
Test alarm protocol	*31*	- #	0 = P100 3 = CPC 4 = Caller ID

Alarm Type	Code	Data	Comments
Alarm type 1st number	*41*	--#	Only when using CPC as alarm protocol Normally 10 or 27, check with your alarm company!
Alarm type 2nd number	*42*	--#	
Alarm type 3rd number	*43*	--#	
Alarm type 4th number	*44*	--#	
Alarm type LMS	*45*	--#	LMS (Lift Monitoring System) (Battery alarm) Normally 17
Alarm type Test alarm	*46*	--#	Normally 26
Distress message	Code	Data	Comments
Record distress message played in the lift car	*51*	"Speak" #	This message will be played in the lift car when the emergency lift telephone starts calling the alarm centre. Make sure that there is no noise in the background when recording the message. <b>Example of message:</b> Please do not panic, the emergency telephone is now calling the emergency call centre.
Record alarm message from Lift Car to alarm central	*52*	"Speak" #	This message will be played to the alarm receiver and in the car when the call is answered. Make sure that there is no noise in the background when recording the message. <b>Example of message:</b> This is an alarm from the lift on 5th avenue. To hear the quality of the message, press "1". To terminate the call press "##".
Options for the recorded distress message	*61*	- #	To play the recorded message, press the desired parameter followed by #.
	*61*	#	
Options for the recorded message from Lift Car	*62*	- #	0 = Disable recorded message. 1 = Enables recorded message.
	*62*	#	

Other codes	Code	Data	Comments
Emergency signal in speaker	*71*	- #	The speaker siren will sound at emergency call. 0 = Off (default) 1 = On
Ring-tone timeout	*72*	- - #	Number of ring signals before dialling the next number (default = 08).
Additional input function (serial no. < 27000)	*73*	- #	Selects input function: 0 = None (Default) 1 = Filter, blocks the alarm input when active. 2 = LMS (Lift Monitoring System), sends a lift monitoring alarm at input activation. 3 = Clear/Maintenance 4 = Call Delay
Additional input function (serial no. > 27000)	*73*	x y #	X= Input 1 or 2 Y= Function: 0 = None (Default) 1 = Filter, blocks the alarm input when active. 2 = LMS (Lift Monitoring System), sends a lift monitoring alarm at input activation. 3 = Clear/Maintenance 4 = Call Delay 5 = Battery Low 6 = Alarm Button Example: 22 = input 2 with LMS
Additional input type (serial no. < 27000)	*74*	- #	0 = Normally-open contact, N/O (Default) 1 = Normally-closed contact, N/C
Additional input type (serial no. > 27000)	*74*	x y #	X= Input 1 or 2 Y= Type: 0 = Normally-open contact, N/O (Default) 1 = Normally-closed contact, N/C Example: 21 = input 2 with N/C
Hotline	*75*	- #	Phone connects directly to a fixed recipient without phone number 0 = Standard phone line (default) 1 = Hotline
Volume control	*76*	- #	Adjustable volume, between 1-6. (Default = 4)



Other codes	Code	Data	Comments
Compatibility mode	*77*	- #	<p><b>0 = Automatic voice switching</b> The call is validated when there is a voice response. The call is terminated by pressing "#".</p> <p><b>1 = Kone ECI (lift telephone)</b> When there is a voice response, some ascending tones will be heard. The call is validated by pressing "4". The call is terminated by pressing "0". The call is terminated without receipt notification by pressing "2"(the unit will call the next number).</p> <p><b>2 = Manual voice switching</b> When there is a voice response, some ascending tones will be heard. The call is validated by pressing "4". Unit is still in automatic mode. To enter manual mode and talk press "**". To listen press "7". Go back to automatic mode press "4". The call is terminated by pressing "#". It is possible to enter manual voice switching mode although the unit is programmed as automatic by pressing "**". No ascending tones will be heard. For repeating the Alarm messages to operator, press "1" in all in/out going calls.</p> <p><b>3 = Swiss M (Alarm operator mode)</b> Only to be used in voice mode. Disconnect by "0". Dials the next number if call timeout, blocking tone, new dialing tone, and operator silence.</p>
Indicator mode	*78*	- #	<p>0 = Standard (default) 1 = Strictly EN81-28 2 = Strictly single EN81-28</p>
Voice communication time-out	*79*	-- #	<p>Value 1 - 20 minutes. 05 = default value 08 = default value for other protocols</p>
Reset active alarm automatically	*80*	- #	<p>0 = Off 1 = On (default)</p>
Auto answer	*81*	-- #	<p>Number of signals before SafeLine answers incoming call. Can be set from 00-16 (default = 02). 00 = Never answering.</p>
Unit number	*82*	- #	<p>Unit number [0] is set by default, and means that the unit will respond immediately. Unit number [1-9] is used when the units are sharing the same phone line. When the unit number is assigned, the specified unit is accessible for configuration.</p>
Detect dial tone	*83*	- #	<p>0 = Off 1 = On (default) Set to off if SafeLine has problem to detect the dial tone.</p>
Receipt to alarm receiver with P100 protocol	*84*	- #	<p>Select which message(s) to send to the alarm receiver at an alarm call. 0 = None (default) 1 = Start of alarm 2 = Start+end of alarm</p>

Other codes	Code	Data	Comments
Break on new alarm	*86*	- #	Disconnects a call longer than 60 seconds at new activation of the alarm button and calls the next emergency call number. 0 = Off 1 = On (default)
Alarm button delay time	*87*	-- #	Delay time from pressing the alarm button until activating the alarm. 00-25 seconds. Default = 05
Outputs	*88*	-- #	The first digit specifies the output, i.e Output 1 or Output 2. The second digit specifies the function: 0 = Pictogram (Output 1 - Yellow, Output 2 - Green) 1 = Activate with DTMF 8/9 (Output 1 - DTMF 8, Output 2 - DTMF 9) 2 = System failure 3 = Alarm <b>Example:</b> *88*11# - Output 1, Activate with DTMF 8 *88*23# - Output 2, Alarm
Alarm button type	*89*	- #	0 = Normally-open contact, N/O (Default) 1 = Normally-closed contact, N/C
Microphone sensitivity	*90*	- #	The sensitivity of the microphone can be reduced in three levels. 0 = No reduction (default) 1 = 20 % Reduction 2 = 40 % Reduction 3 = 60 % Reduction
Change password	*91*	--- #	Change password (default=0000).
Operator silence disconnect	*92*	- #	Disconnects the call when the alarm operator has been quiet for longer than the time set. 0 = Off (default) 1 = 30 sec 2 = 60 sec 3 = 90 sec
Simulate an alarm event	*94*	- #	Triggers an alarm event after configuration is terminated. 1 = Emergency call 2 = Test alarm 3 = Battery failure 4 = Microphone/Speaker failure 5 = Receipt on voice call 6 = Maintenance 7 = Main unit power failure 8 = Stuck button alarm
Reset to default settings	*99*	- #	<b>1 = Factory standard</b> <b>2 = Default P100 (The following codes will be set):</b> *21*0#, *22*0#, * 27*03#, *76*4#, *80*1#, *84*1#, *88*1# <b>3 = Default CPC (The following codes will be set):</b> *21*3#, *22*3#, *27*03#, *76*4#, *80*1#, *84*1#, *88*1# <b>4 = Default VOICE (The following codes will be set):</b> *21*1#, *22*1#, *27*03#, **76*4#, 80*1#, *84*1#, *88*1#

# Operation

## LED indication for pictogram in car



### Yellow LED

#### Call in progress

The yellow pictogram LED is lit as soon as the alarm button is pressed.



### Green LED

#### Call connected

The green pictogram LED turns on as soon as the SafeLine unit detects a responding voice. The LED is turned off when the call is terminated.

### Extended (\*78\*0#)

Light off

### Yellow LED

No alarm activated

### Green LED

Telephone line not OK.

Flashing slowly

**Flashing once every 5 seconds**  
Telephone line not OK.

**Flashing once every 5 seconds**  
Unit is OK.

Flashing quickly

**Flashing twice every second**  
Alarm button active.

**Flashing two times every 5 seconds**  
Alarm filter activated.

Continuous light

Activated alarm. Remains lit until reset.

Call connected.

### Strictly EN81-28 (\*78\*1#)

Flashing

### Yellow LED

**Flashing twice every second**  
Alarm button active.

### Green LED

Continuous light

Activated alarm. Remains lit until reset.

Call connected.

### Test alarm failure

Light on for 1 second then light off for 1 second

### Yellow LED

**Test alarm (line check) failed**  
Returns to normal at next valid test alarm.

### Green LED

**Test alarm (line check) failed**  
Returns to normal at next valid test alarm.

# Testing

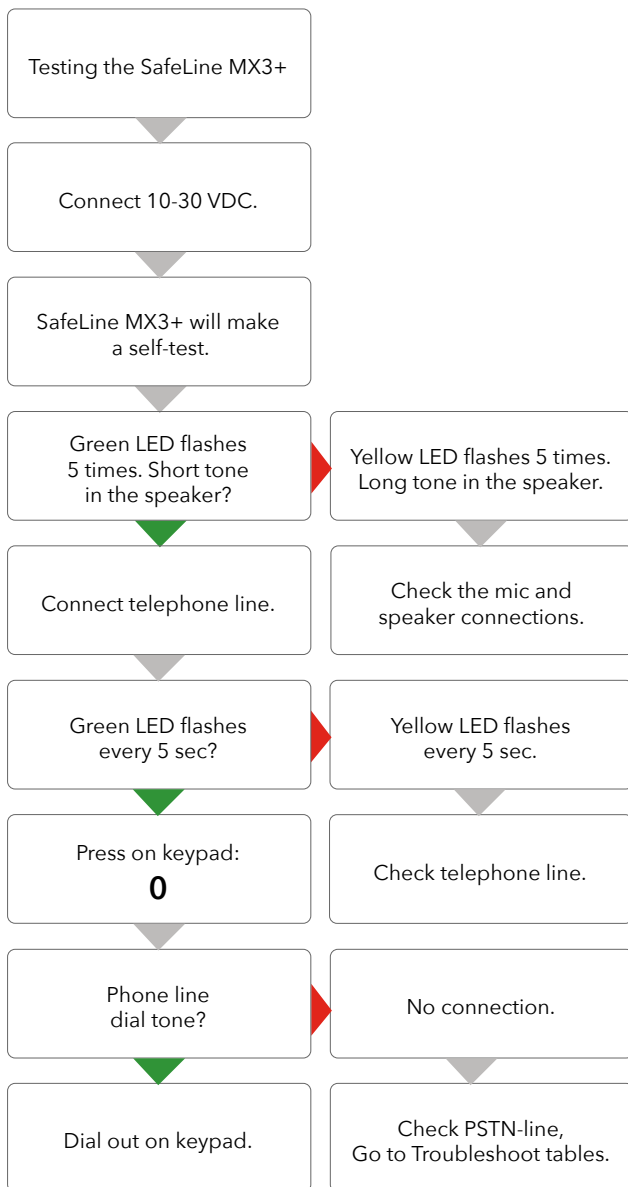

# Emergency calling process

Maximum 12 calls: with 4 stored telephone numbers, each number could be called 3 times. This adds up to the 12 call limit. To restart the dialling process, another push of the alarm button is needed.

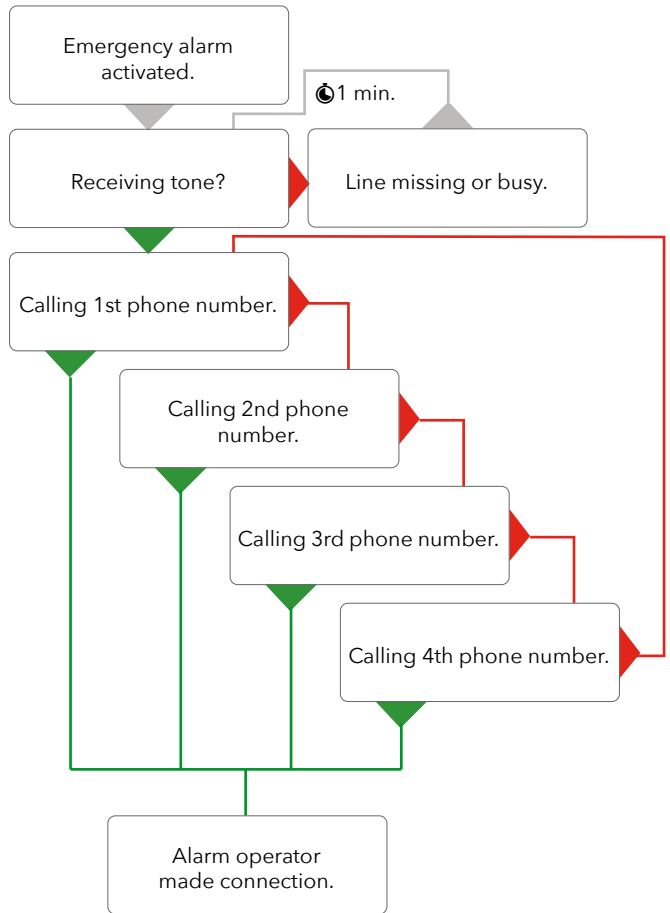

---

# Trouble-shooting

## The telephone beeps every 5 seconds

This is to notify the passengers of the ongoing call (anti eaves dropping).

## The unit makes an alarm call when powered up

- Improper type of emergency button selected. Change from N/C to N/O or from N/O to N/C.
- Emergency button is stuck.

## No sound transmitted from the lift car to the call receiver

Press "0" to get an outside line. Make a call. If the sound transmission is OK in both directions, check if your emergency operator supports the chosen alarm type. If no protocol is used, change the call type to "VOICE". If no sound is transmitted from the lift car, check the microphone.

## Poor/distorted sound quality

Volume might be set too loud! Lower the volume and check again.

## Interfering noise when the call is connected

The problem might be due to induction in the phone cable. According to the phone companies' regulations, the phone line must be installed in a separate cable.

## GSM noise

Change the antenna position when a call is connected until you find the optimal antenna position. Do not install the antenna near the unit or close to the cabelling.

## Cannot dial out

- Broken line connection (LED not blinking green).
- No money on refill SIM-card, verify the SIM-card by inserting it into a normal mobile phone.

## No voice switching

- The volume is set too high.
- The problem might be due to induction in the phone cable.

## The unit can not make an alarm call

At least one phone number (and one ID code if using data identification) must be configured to enable making a call from the unit. Refer to the parameter list (\*11\*).

---

### Emergency button N/C



### Emergency button N/C



## EU Declaration of Conformity

Product: Lift telephone  
 Type / model: **SafeLine MX3**  
 Article no: \*SLMX3-COP, \*SLMX3-COP2, \*SLMX3-LENS90, \*SLMX3-REC-PIC, \*SLMX3-REC-PICB,  
 \*SLMX3-SM-PIC, \*SLMX3-SM-PICB, \*SLMX3-SMD-PICB, \*RU-SLMX30005  
 Manufacturer: SafeLine Sweden AB  
 Year: 2020

We herewith declare under our sole responsibility as manufacturer that the products referred to above complies with the following EC Directives:

### Directives

Radio Equipment (RED):	2014/53/EU
RoHS 2:	2011/65/EU

### Standards applied

EN 81-20:2014	Lift: Safety & Technical requirements
EN 81-28:2003	Lift: Remote alarm on passenger and goods passenger lifts
EN 81-70:2003/A1:2004	Lift: Accessibility to lifts for persons including persons with disability
EN 12015:2014	EMC: Emission, Electromagnetic compatibility
EN 12016:2013	EMC/Lifts: Immunity, Electromagnetic compatibility
EN 62368-1:2014/AC:2015	LVD: Information Technology Equipment
EN 50581:2012	RoHS: Technical doc. for assessment of restriction of RoHS.
TBR21/CTR21	PSTN Terminal equipment

For RED 2014/53/EU, the conformity assessment procedure "Module A" used as described in Annex II. Accordingly, respective manufacturer has done the radio modules conformity assessment:

Standards applied	Article of Directive 2014/53/EU
-------------------	---------------------------------

EN 60950-1:2006+A11:2009+A12:2010+A12:2011	3.1 (a): Health and safety of the user
EN 62311:2008	
EN 301 489-1 v2.1.1 + EN 301 489-52v1.1.0 Draft	3.1 (B): Electromagnetic Compatibility

Module	Notified body	Address	NB nr	Test nr
CYW20732S	NTS Silicon Valley	41039 Boyce Road, Fremont, CA 94538, US	0214.26	R 104750/51

EN 301 489-17 V3.1.1	
EN 300 328 V2.1.1	3.2: Effective use of spectrum allocated

### Firmware used during assessment

SafeLine MX3:	1.00
---------------	------

Tyresö, 2020-02-05

  
 Lars Gustafsson,  
 Technical Manager, R&D , SafeLine Group

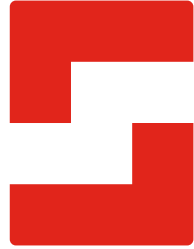
**SafeLine Headquarters**

Antennvägen 10 · 135 48 Tyresö · Sweden  
Tel.: +46 (0)8 447 79 32 · info@safeline.se  
Support: +46 (0)8 448 73 90

**SafeLine Denmark**

Vallensbækvej 20A, 2. th · 2605 Brøndby · Denmark  
Tel.: +45 44 91 32 72 · info-dk@safeline.se

**SafeLine Norway**

Solbråveien 49 · 1383 Asker · Norway  
Tel.: +47 94 14 14 49 · post@safeline.no

**SafeLine Europe**

Industrieterrein 1-8 · 3290 Diest · Belgium  
Tel.: +32 (0)13 664 662 · info@safeline.eu  
Support: +32 (0)4 85 89 08 95

**SafeLine Deutschland GmbH**

Kurzgewannstraße 3 · D-68526 Ladenburg · Germany  
Tel./Support: +49 (0)6203 840 60 03 · sld@safeline.eu

**SafeLine Group UK**

Unit 47 · Acorn Industrial Park · Crayford ·  
Kent · DA1 4AL · United Kingdom  
Tel.: +44 (0) 1322 52 13 96 · info@safeline-group.uk

SafeLine is a registered trademark of SafeLine Sweden AB. All other trademarks, service marks, registered trademarks, or registered service marks are the property of their respective owners.